

**DSE BIOLOGY PAPER 1**

Date: 14<sup>th</sup> Feb. 2019

8:25 am – 10:55 am (2 hours 30 minutes)

This paper must be answered in English

Candidate number: \_\_\_\_\_

**GENERAL INSTRUCTIONS**

1. There are **TWO** sections, A and B, in this paper. You are advised to finish Section A in about 35 minutes.
2. Section A consists of multiple-choice questions in this question book. Section B contains conventional questions printed separately in Question-Answer Book B.
3. Answers to Section A should be marked on the Multiple-choice Answer Sheet while answers to Section B should be written in the spaces provided in Question-Answer Book B. **The Answer Sheet for Section A and the Question-Answer Book for Section B must be handed in separately at the end of the examination.**

---

**INSTRUCTIONS FOR SECTION A (MULTIPLE-CHOICE QUESTIONS)**

1. Read carefully the instructions on the Answer Sheet. Insert the information required in the spaces provided.
2. When told to open this book, you should check that all the questions are there. Look for the words “**END OF SECTION A**” after the last question.
3. All questions carry equal marks.
4. **ANSWER ALL QUESTIONS.** You should use an HB pencil to mark all the answers on the Answer Sheet, so that wrong marks can be completely erased with a clean rubber. You must mark the answers clearly; otherwise you will lose marks if the answers cannot be captured.
5. You should mark only **ONE** answer for each question. If you mark more than one answer, you will receive **NO MARKS** for that question.
6. No marks will be deducted for wrong answers.
7. The diagrams in this section are **NOT** necessarily drawn to scale.

Not to be taken away before  
the end of the examination

*There are 36 questions in this section.*

*The diagrams in this section are not necessarily drawn to scale.*

**Directions:** Questions 1 and 2 refer to the electron micrograph below which shows a blood cell:

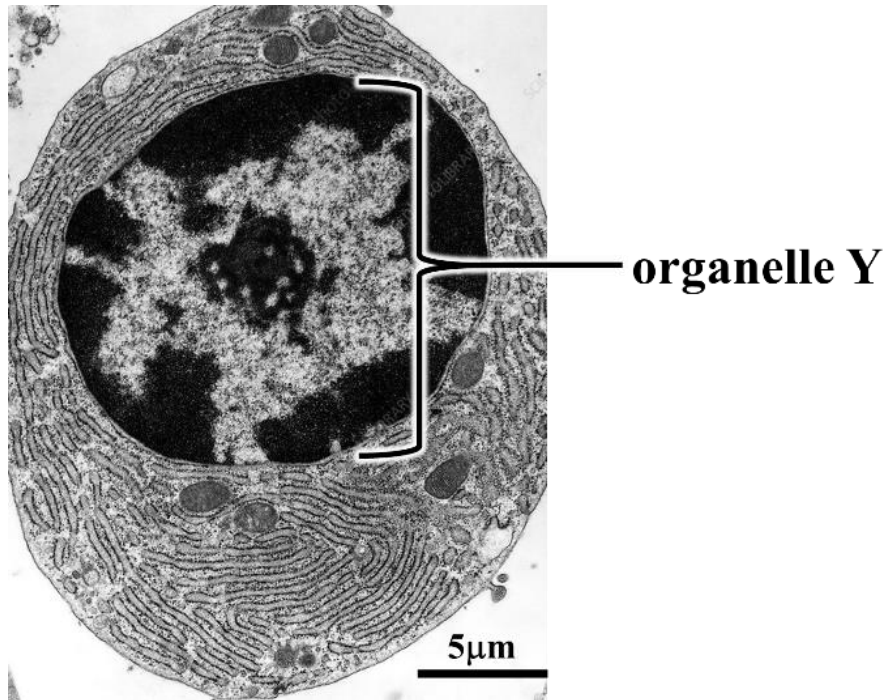

1. Which of the following deductions can be drawn from the above electron micrograph?

- (1) The cell cannot move on their own.
- (2) The cell undergoes cell division actively.
- (3) The cell undergoes protein synthesis actively.

- A. (3) only
- B. (1) and (3) only
- C. (2) and (3) only
- D. (1), (2) and (3)

2. Which of the following chemicals can be found in organelle Y?

- (1) DNA
- (2) RNA
- (3) Protein

- A. (1) only
- B. (1) and (2) only
- C. (2) and (3) only
- D. (1), (2) and (3)

3. Donald observed the money plant epidermis with a light microscope. He first obtained the view as shown in *Image A*. Then he made some adjustments in order to obtain the view as shown in *Image B*.

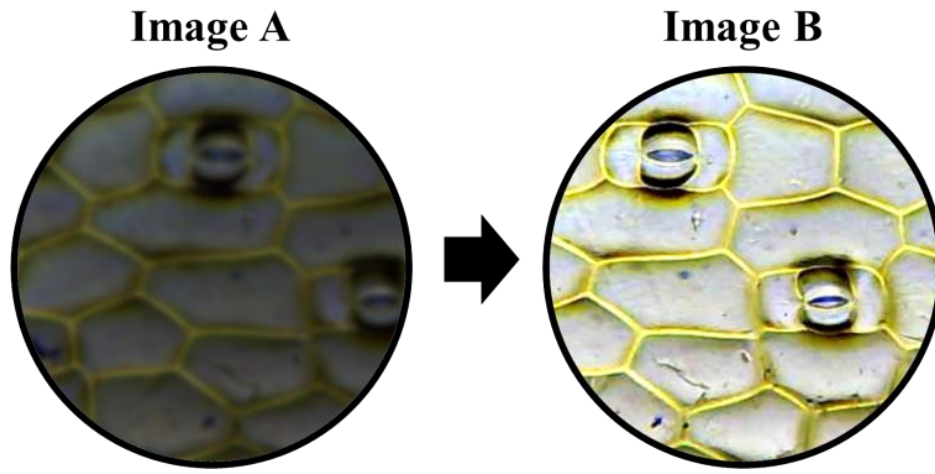

Which of the following adjustments are necessary for Donald to obtain the view in Image B?

- (1) Turn to an objective lens with higher magnification
  - (2) Move the specimen towards the right hand side
  - (3) Adjust the fine adjustment knob
  - (4) Increase the aperture size of iris diaphragm
- A. (1) and (2) only  
B. (3) and (4) only  
C. (2), (3) and (4) only  
D. (1), (2), (3) and (4)
4. Which of the following events occur(s) in metaphase of mitotic cell division?
- (1) Chromosomes attach to the spindle fibres at centromeres.
  - (2) Chromosomes line up along the equatorial plane of the cell.
  - (3) Chromosomes being pulled apart towards opposite poles of the cell.
- A. (1) only  
B. (3) only  
C. (1) and (2) only  
D. (2) and (3) only

5. A student viewed a large number of cells from an onion root tip under microscope and recorded the number of cells in each stage of the cell cycle. The results were shown in the table below:

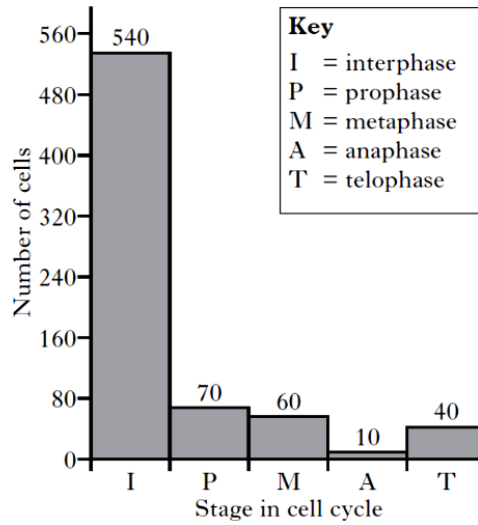

In average the percentage length of time of an onion root cell spent in mitotic cell division is around

- A. 19%
  - B. 25%
  - C. 33%
  - D. 75%
6. The photomicrographs below show the appearance of red blood cells after immersing in solutions A, B and C for 30 minutes:

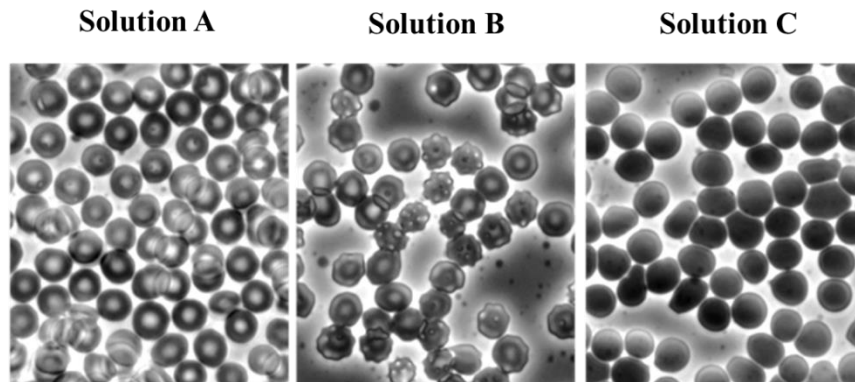

Which of the following correctly compares the water potentials of solutions A, B and C?

- A.  $C > B > A$
- B.  $C > A > B$
- C.  $A > B > C$
- D.  $A > C > B$

7. The diagram below shows an experimental setup to study osmosis. A dialysis tubing permeable to substances with molecule size smaller than disaccharides was used in the experiment:

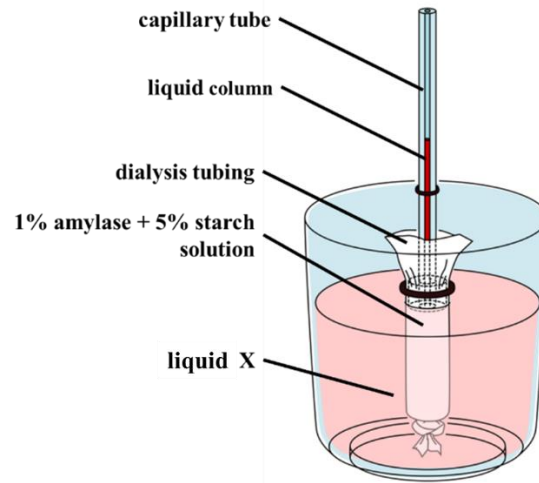

After 2 hours, the height of the liquid column in capillary tube increased. Liquid X must **not** be

- A. distilled water
  - B. 5% starch solution
  - C. boiled 1% amylase + 5% starch solution
  - D. 1% amylase + boiled 5% starch solution
8. Which of the following statements about the emulsification of oil by bile in human body is correct?
- (1) Oil is broken down into glycerol and fatty acids.
  - (2) The rate of emulsification is the highest at 37°C.
  - (3) It takes place in the duodenum.
- A. (1) only
  - B. (3) only
  - C. (1) and (3) only
  - D. (2) and (3) only

**Directions:** Questions 9 and 10 refer to the diagram below which shows an experimental set-up investigating the respiration rate of mealworms at room temperature. Ten mealworms were added to a boiling tube and the position of the coloured liquid column was measured from time to time:

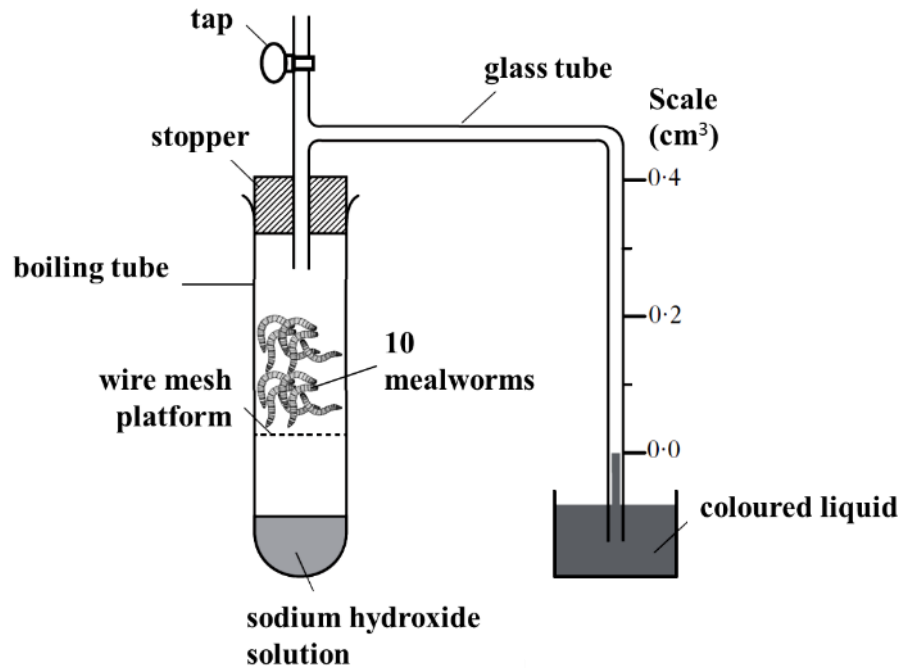

9. After 10 minutes, the coloured liquid column rose to 0.2 cm<sup>3</sup>. What is the average respiration rate of *one* mealworm?
- 0.002 cm<sup>3</sup> O<sub>2</sub>/min
  - 0.02 cm<sup>3</sup> O<sub>2</sub>/min
  - 0.002 cm<sup>3</sup> CO<sub>2</sub>/min
  - 0.02 cm<sup>3</sup> CO<sub>2</sub>/min
10. If the experiment is repeated at 4°C, which of the following is the most possible outcome?
- The reading does not rise after 10 minutes.
  - The rise of the reading after 10 minutes will become smaller.
  - The rise of reading after 10 minutes will remain the same.
  - The rise of reading after 10 minutes will become larger.

11. The graph below shows the effect of exercise intensity on blood lactic acid and oxygen level in aorta:

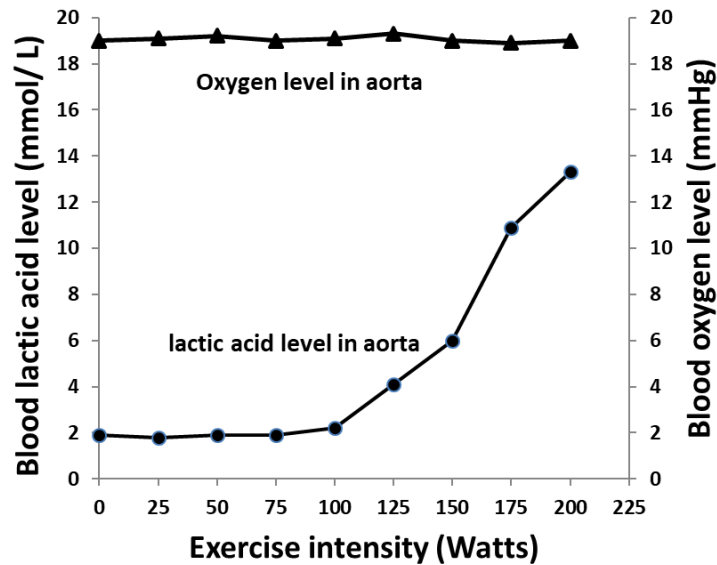

Peter ran at an intensity of 75 Watts in order to catch the bus. Which of the following correctly predicts and explains Peter's breathing rate when he just arrived at the bus stop?

- |    | <i>Peter's breathing rate</i> | <i>Explanation</i>  |
|----|-------------------------------|---|
| A. | increase                      | To pay oxygen debt developed during running                           |
| B. | increase                      | To sustain oxygen supply for an increased rate of aerobic respiration |
| C. | same as resting state         | Lactic acid was not produced during running                           |
| D. | same as resting state         | His blood lactic acid level remained at normal level                  |

12. The electron micrograph below shows a chloroplast:

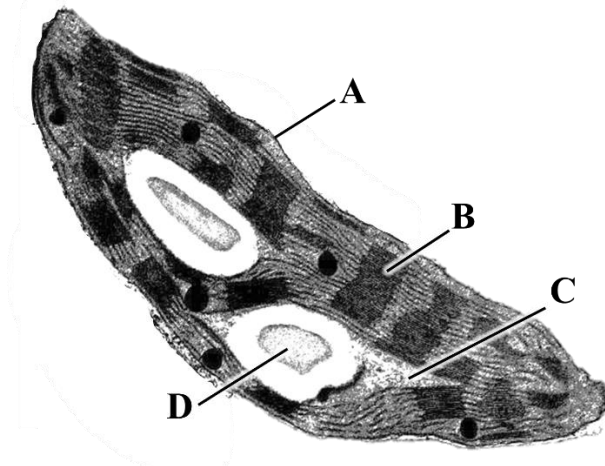

Which the above structures is the production site of oxygen?

13. The graph below shows the concentrations of 5-C compound and 3-C compound in chloroplast of algal cells kept in a sealed flask with constant carbon dioxide supply. The flask was illuminated for 3 minutes but then the light source was switched off.

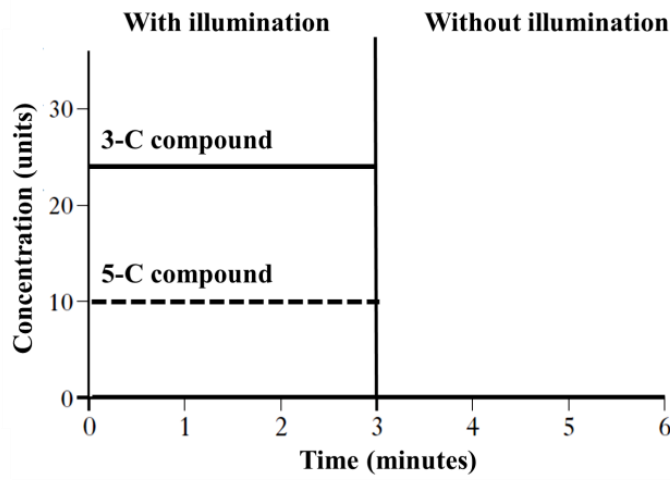

Which of the following graphs best shows the concentration changes when the light source was switched off?

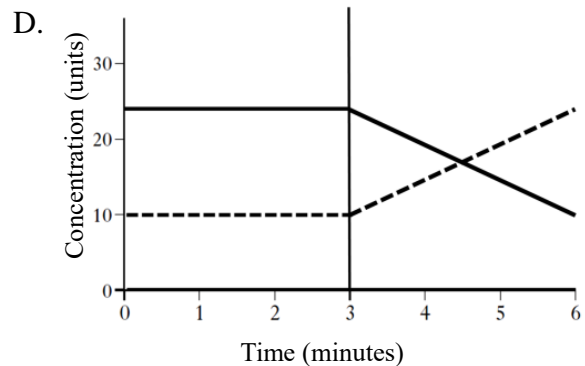
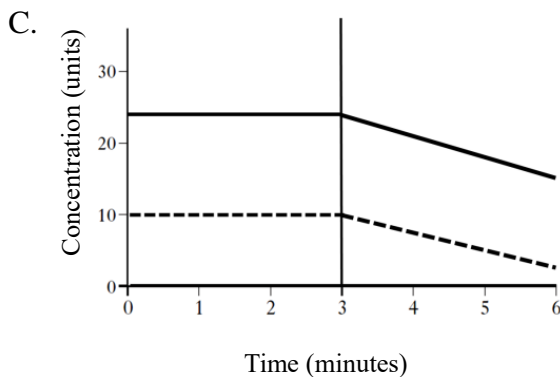
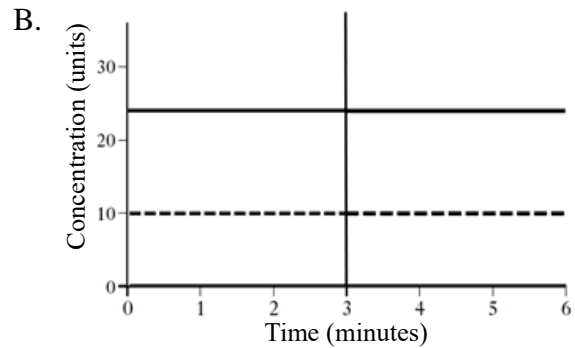
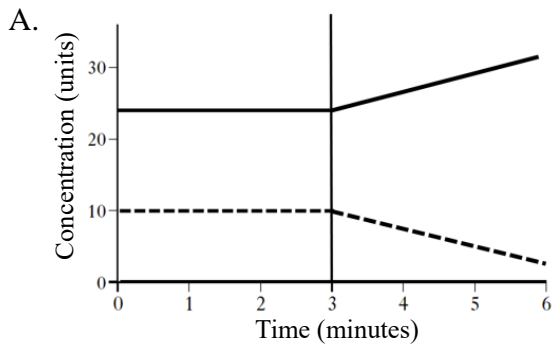



14. The graph below shows the change in air pressure in the lungs of a man. The atmospheric pressure is 760 mm Hg.

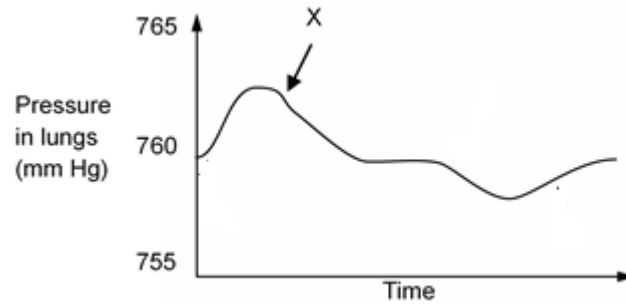

Which of the following combinations correctly shows what happens at time point X?

- |    | <i>Diaphragm muscles</i> | <i>Ribs and sternum</i> | <i>State of ventilation</i> |
|----|--------------------------|-------------------------|-----------------------------|
| A. | contract                 | move up                 | inhalation                  |
| B. | contract                 | move down               | exhalation                  |
| C. | relax                    | move up                 | inhalation                  |
| D. | relax                    | move down               | exhalation                  |
15. Paul finds that his feet swell after a long flight of 13 hours from UK back Hong Kong. Which of the following best explains this phenomenon?
- The atmospheric pressure is getting lower with the increase in the altitude. The decrease in the atmospheric pressure makes most water in the tissue fluid more difficult to return to the capillaries.
  - In the plane, less oxygen is carried in the blood and so the heart pumps faster. Therefore, the water of the tissue fluid cannot return to the blood as fast as the blood flow.
  - The lack of skeletal muscle contractions reduces the blood flow rate in the veins, leading to the accumulation of blood in the legs.
  - The lack of skeletal muscle contractions reduces the flow rate of lymph in the lymph vessels, leading to the accumulation of excess tissue fluid in the legs.

16. The diagram below shows the vertical section of a human heart and its main blood vessels.

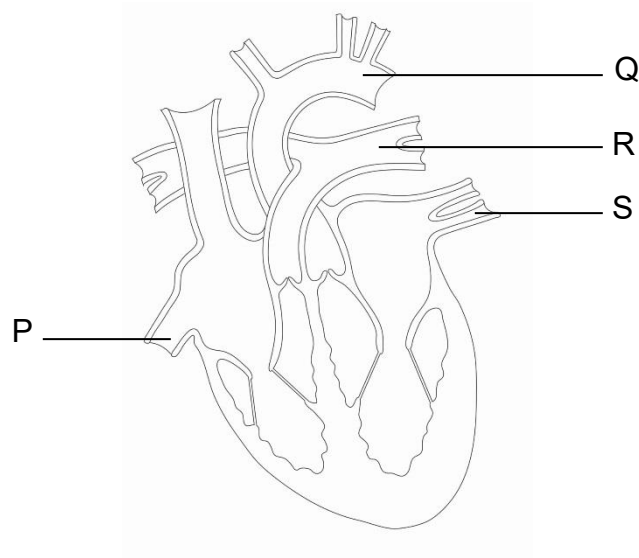

Which of the following statements concerning blood vessels P, Q, R and S is/are correct?

- (1) Blood vessel S first receives blood with nicotine when a person is smoking.
- (2) Blood vessel R carries deoxygenated blood at a lower blood pressure than that in P.
- (3) Blood vessel Q has the thickest wall for generating strong force to pump out the blood.

- A. (1) only
- B. (1) and (2) only
- C. (2) and (3) only
- D. (1), (2) and (3)

17. The diagram on the right shows the carpel of a flower. Which of the following combinations correctly matches the floral part with the seed structure developed after fertilization?

	<i>Floral part</i>	<i>Seed structure</i>
A.	1	Plumule and radicle
B.	2	Integument
C.	3	Fruit wall
D.	4	Hilum

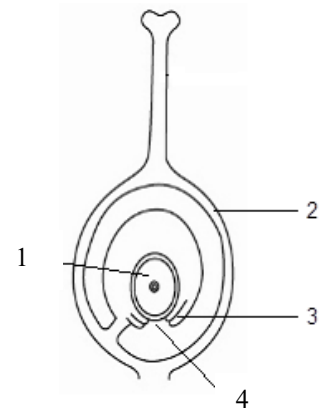

18. The diagram below shows a set-up used to measure the rate of transpiration of a leafy shoot. The reading of the electronic balance and the burette after the set-up was left under bright light for five hours is given in the table.

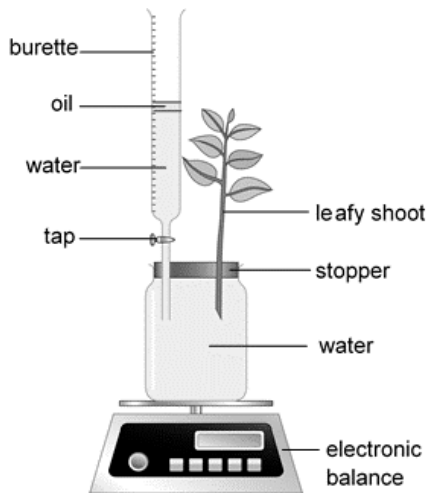

	Reading of the electronic balance (g)	Reading of the burette (cm <sup>3</sup> )
Initial reading	200.0	40.0
Final reading	197.5	37.0

Which of the following is correct?

- A. The rate of water absorption by the leafy shoot is 3.0 cm<sup>3</sup>/h.  
 B. The rate of transpiration of the leafy shoot is 0.5 cm<sup>3</sup>/h.  
 C. The final reading of the burette will be smaller than 37 if the set-up is placed in a dim room.  
 D. The final reading of the electronic balance will be smaller than 197.5 if the set-up is placed in a dim room.
19. Which action is taken by a B cell activated by an antigen on the pathogen?
- A. It attaches to the pathogens and cause them to clump together.  
 B. It divides repeatedly to form a clone of genetically identical plasma cells.  
 C. It engulfs the pathogen.  
 D. It secretes lymphokines which activates T cells to produce plasma cells.
20. The synthesis of specific antibodies in response to vaccination is an example of
- A. natural active immunity  
 B. artificial active immunity  
 C. natural passive immunity  
 D. artificial passive immunity

21. The diagram below shows a section through an eye. Which part is the receptor for the stimulus that results in a change in pupil size?

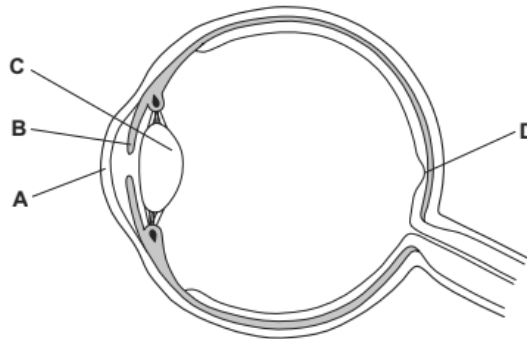

22. The diagram below shows the main muscles and bones of the arm.

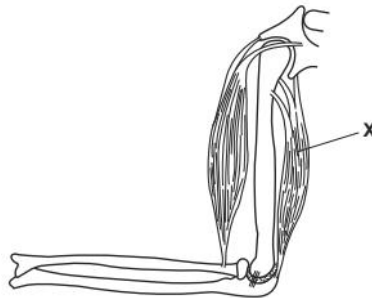

What happens when muscle X contracts?

- A. The lower arm is extended.
  - B. The lower arm is raised.
  - C. The upper arm is lowered.
  - D. The upper arm is raised.
23. Which of the following is *not* an example of negative feedback in human?
- A. A decrease in surrounding temperature leads to a decrease in sweating.
  - B. A decrease in surrounding temperature leads to a decrease in blood flow to the skin surface.
  - C. A decrease in surrounding temperature leads to a decrease in respiration rate.
  - D. A decrease in surrounding temperature leads to shivering.
24. What does the hypothalamus control?
- A. Body temperature
  - B. Heart rate
  - C. Insulin secretion
  - D. Rate of breathing

25. Which of the following are correct for a genetic disorder caused by an X-linked recessive allele?

- (1) The disorder is never passed from father to son.
- (2) females are much more likely to be affected than males.
- (3) All affected males in a family receive the disorder through their mothers.

- A. (1) and (2) only
- B. (1) and (3) only
- C. (2) and (3) only
- D. (1), (2) and (3)

26. Which of the following modes of inheritance *cannot* be shown by the pedigree below?

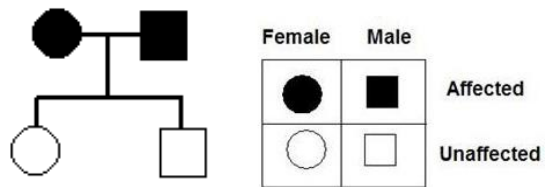

- (1) Autosomal dominant
- (2) Autosomal recessive
- (3) X-linked dominant

- A. (1) and (2) only
- B. (1) and (3) only
- C. (2) and (3) only
- D. (1), (2) and (3)

27. The following organisms form a food chain in a forest:

- (1) a tree
- (2) blood sucking ticks
- (3) fruit-eating birds

Which of the following pyramids of biomass correctly represents the food chain?

A.

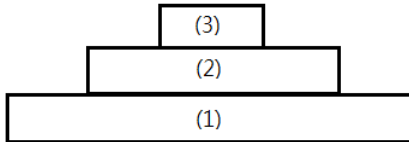

B.

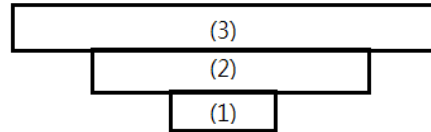

C.

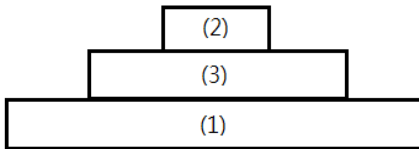

D.

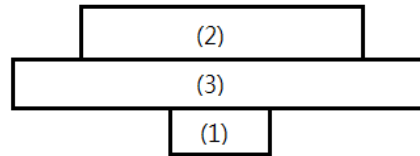

28. *Mikania micrantha* is a climbing plant. Its leaves grow vigorously and will cover up other plants. This will eventually damage or kill other plants by cutting out the light for photosynthesis.



Natural vegetation covered by Mikania.

The ecological relationship between Mikania and the plant it climbs is

- A. mutualism
- B. commensalism
- C. parasitism
- D. competition

29. Mikania is a problematic weed in Hong Kong as it affects natural vegetation and landscape features. Researchers explore the effectiveness of using dodder, a parasitic angiosperm to a variety of plants, to control the growth of Mikania.



Which of the following statements about employing dodder as the biological control agent is/are correct?

- (1) Dodder slows down growth of Mikania by absorbing the photosynthetic products from Mikania directly.
  - (2) Dodder will not spread to other areas as it won't produce seeds.
  - (3) Dodder will not cause disturbance to the ecosystem as it only infests Mikania.
- A. (1) only  
B. (1) and (3) only  
C. (2) and (3) only  
D. (1), (2) and (3)

30. The table below shows the classification of four organisms:

Kingdom	Animalia			
Phylum	Chordata			
Class	Mammalia			
Order	Primates			
Family	Hominidae		Cercopithecidae	
Genus	<i>Homo</i>		<i>Theropithecus</i>	<i>Papio</i>
Species	<i>sapiens</i> (modern human)	<i>habilis</i> ("handy human")	<i>gelada</i> (Gelada)	<i>anubis</i> (Olive baboon)

Which of the following diagrams best represents the evolutionary tree of the four organisms?

A.

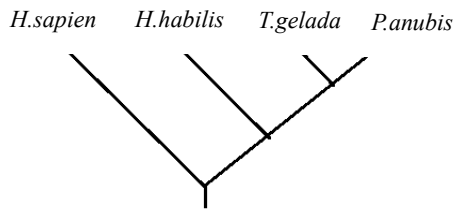

B.

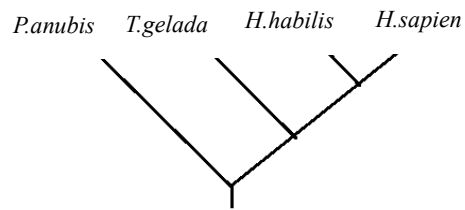

C.

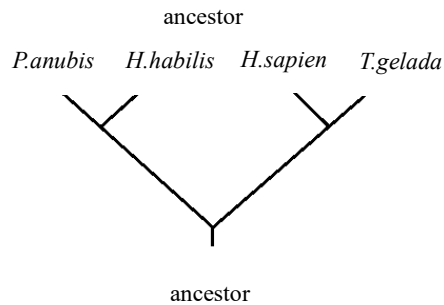

D.

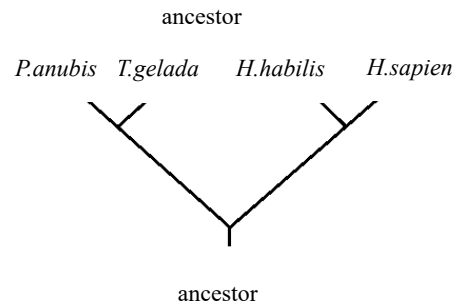

31. Which of the following may increase the genetic variation in a population?

- (1) meiosis
- (2) speciation
- (3) natural selection

- A. (1) only
- B. (1) and (2) only
- C. (2) and (3) only
- D. (1), (2) and (3)



32. The dichotomous key below can be used to identify five species of birds.

- |       |   |                                 |
|-------|---|---------------------------------|
| 1 (a) | has a hooked beak.....                                      | 2                               |
| 1 (b) | has a straight beak.....                                    | 3                               |
| 2 (a) | has a white head and a brown body.....                      | <i>Haliaeetus leucocephalus</i> |
| 2 (b) | has a brown back and a white abdomen with barred brown..... | <i>Accipiter virgatus</i>       |
| 3 (a) | has a long, deeply forked tail.....                         | <i>Hirundo rustica</i>          |
| 3 (b) | its tail is not forked.....                                 | 4                               |
| 4 (a) | has a white stripe behind the eyes.....                     | <i>Sphyrapicus thyroideus</i>   |
| 4 (b) | no white stripe behind the eyes.....                        | <i>Dryocopus martius</i>        |

Use the given dichotomous key to identify the following bird.



- A. *Sphyrapicus thyroideus*
- B. *Dryocopus martius*
- C. *Accipiter virgatus*
- D. *Hirundo rustica*

33. The diagram below shows the nitrogen cycle in an aquatic ecosystem.

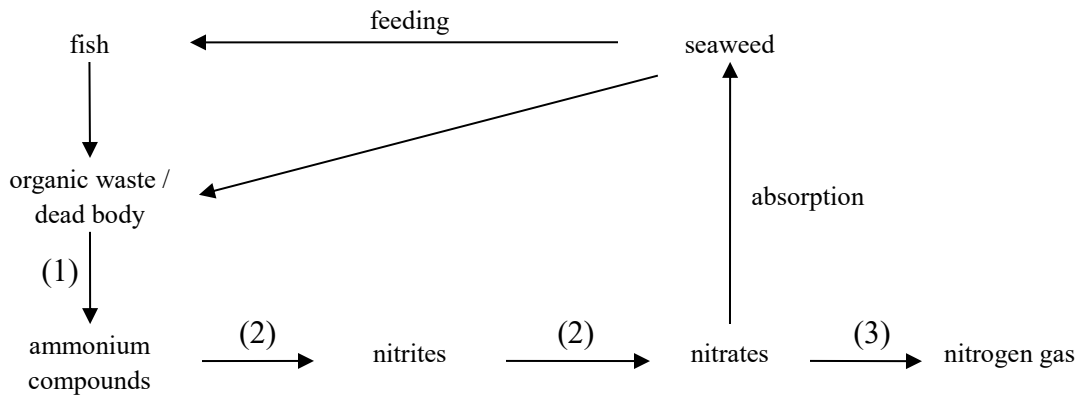

What organisms are involved in processes (1) to (3)?

- |    | <b><i>Process (1)</i></b> | <b><i>Process (2)</i></b> | <b><i>Process (3)</i></b> |
|----|---------------------------|---------------------------|---------------------------|
| A. | saprophytic bacteria      | nitrifying bacteria       | denitrifying bacteria     |
| B. | denitrifying bacteria     | saprophytic bacteria      | nitrogen fixing bacteria  |
| C. | nitrogen fixing bacteria  | nitrifying bacteria       | denitrifying bacteria     |
| D. | nitrifying bacteria       | nitrogen fixing bacteria  | saprophytic bacteria      |

34. The table below shows some features of three organisms:

<b>Organism</b>	<b>True nucleus</b>	<b>Cell wall</b>	<b>Chloroplasts</b>
X	present	present	present
Y	absent	present	absent
Z	present	present	absent

These three organisms could be

- |    | <b>X</b>  | <b>Y</b> | <b>Z</b>  |
|----|-----------|----------|-----------|
| A. | protozoan | yeast    | earthworm |
| B. | algae     | yeast    | fungi     |
| C. | protozoan | bacteria | earthworm |
| D. | algae     | bacteria | fungi     |

35. Quadrat is commonly used in ecological study to isolate a standard unit of area for studying the distribution of a species over a large area. Which of the following organisms are suitable to be sampled by quadrat in a mangrove?



(1) algae



(2) periwinkle



(3) mudskipper

- A. (1) and (2) only
- B. (2) and (3) only
- C. (1) and (3) only
- D. (1), (2) and (3)

36. Three rock outcrops labeled 1,2 and 3, found within the same area are shown below. If the rock layers have not been overturned, which fossil is the oldest?

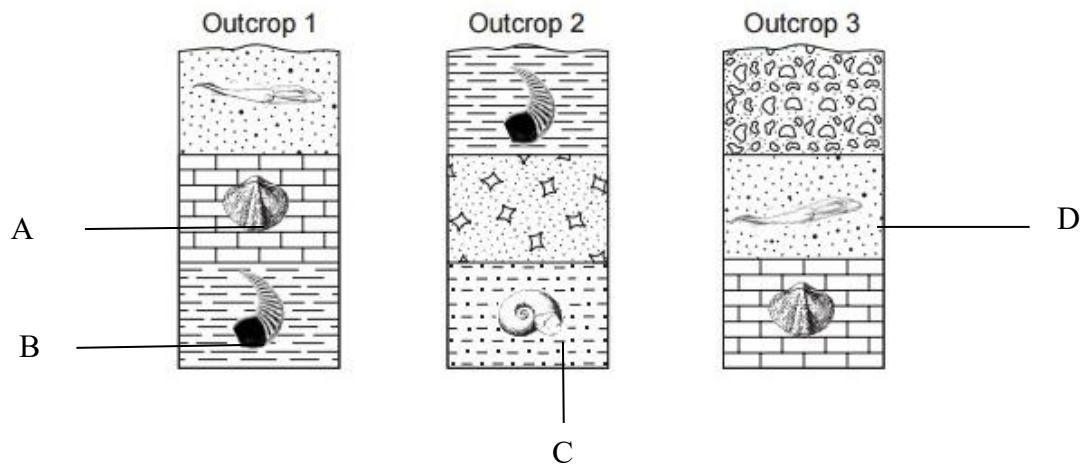

**END OF SECTION A**

**Go on to Question-Answer Book B for questions on Section B**